



A brand of **legrand**

# Light Patrol

Cat. 630/3, 630/3A and 630/3ABL

## Instruction Manual



### 1 Specifications

Detection Method:	Passive infrared
Voltage Supply:	230-240V a.c. 50Hz
Standby power:	0.7W
Max. Lighting Load:	1200W Incandescent 450VA Fluorescent & CFL
Temperature:	-10° C to 45° C
Detection Range:	12m at 24° C
Detection Angle:	180°
Adjustable Angle:	180° vertical
Auto Stop Time:	8 seconds ± 3 seconds (min.) 7 minutes ± 2 minutes (max.)
Lux Level:	From 3 lux to daylight
Built-in manual override function:	Cat 630/3 only
Weather protected:	IP44

### 2 Introduction

The Light Patrol Security Sensor incorporates a passive infrared detector that reacts instantly to body heat and movement. When it senses a person (at a distance of up to 12 metres) it acts as a switch to turn the lights on to which it is connected. When body heat and movement are no longer detected, the lights switch off after a period of time (adjustable). A built-in photocell deactivates the motion sensor during daylight hours if required.

### 3 Features

The Light Patrol provides convenience, security and safety. Convenience for family and friends, lighting their way and making keys easier to locate. Security from intruders who are unexpectedly blasted by light, which usually has the effect of scaring them off. Safety by avoiding accidents caused by unseen obstacles.

### 4 When installing the security sensor pay special attention to these points

1. Do not install when it is raining.
2. Be sure to switch off power source before installing.
3. Make sure the power wiring comes from a circuit protected by a suitable fuse or circuit breaker.
4. For outdoor installation, a location under eaves is preferable.
5. This unit must be installed by a licensed electrician according to local codes and regulations.

### 5 Sensor locations to be avoided

- Directed at swimming pools and ponds. The movement and reflections are likely to create nuisance switching.
- Avoid, if possible, areas which are accessible to animals.
- A position which is subject to drastic changes in temperature.
- In proximity of air conditioner, dryer or heater.
- In direct sunlight.

## 6 Installation

Figure 1.

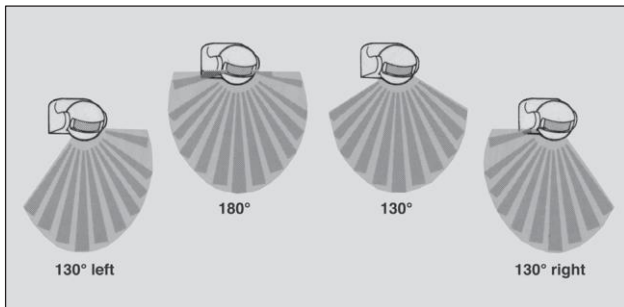
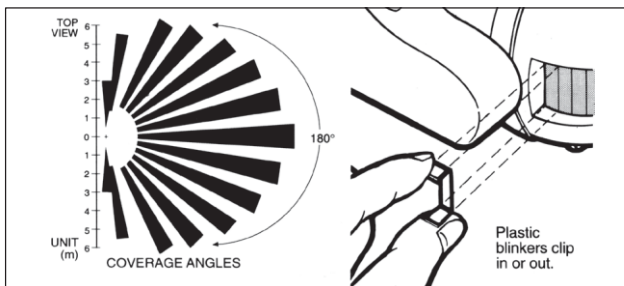

1. Thought should be given to exactly what you would like the Light Patrol to do. This may influence your decision as to where to place it. If for instance you simply wish the lights to turn on when someone approaches your front door, the sensor should monitor the pathway leading to the front door. If however, you have a particular problem area where intruders can enter silently and undetected, you need the Light Patrol to monitor this area.

Added security can be achieved by linking the unit to both outdoor lights and lights or buzzer inside the house.

The Light Patrol monitors a 180° field of view. In practice, however, that scanning width may be too wide. If for instance, the neighbour's driveway is creating nuisance switching (your unit is triggered by cars and people next door) the field of view may need to be restricted.

Four plastic blinkers are supplied. These can be inserted into the corner/s of the lens and will blind the sensor by approx. 13° for each blinker used. All four blinkers will reduce field of view to approx. 130°. These may be inserted one side or the other or shared – depending on the problem that you are attempting to overcome. (see figure 1)

2. Before installation make sure that the power is off

Figure 2.

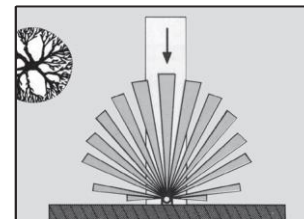
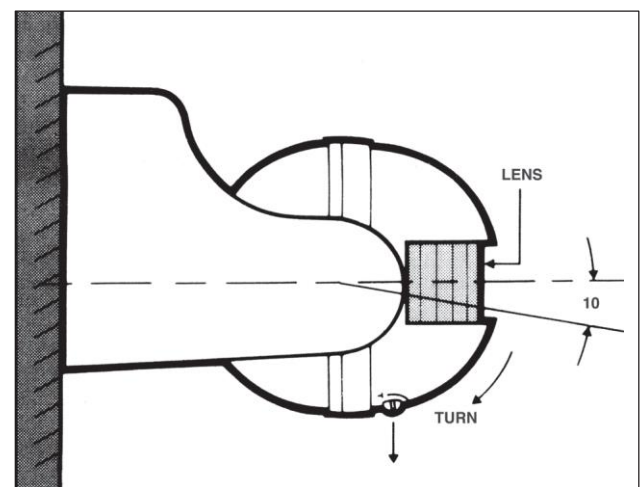

Avoid straight-on monitoring as a person may not be detected walking straight 'into' the sensing area.

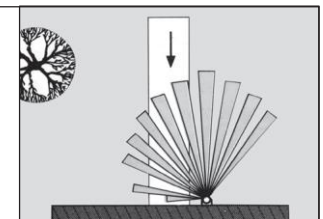

Better to mount obliquely to the expected direction of approach so that the person walks 'through' the sensing area.

on that particular circuit. Remove the fuse or turn off the circuit breaker at the switchboard.

3. Choose a mounting position approximately 2 metres above the area that you wish to monitor. (The unit may be mounted to a height of 4 metres.)

4. Remove the base cover and screw it to the wall or eave through the two screw holes. If brick or concrete, wall plugs may be needed. Note: 'Bottom' is downward. Or, in the case of eave mounting, 'bottom' is closest to the wall (facing away from monitoring area).

5. Connect the Light Patrol to the power source according to the 'wiring instructions'. Then screw the main unit to the base cover.

6. Turn the power on. Start 'walk test' (see TEST MODE on page 3).

Note: Up and down direction of the Light Patrol is called the 'tilting angle'. The bigger the tilting angle the shorter the detection distance – the most ideal tilt angle is between 0° and 10° (see figure 2.)

## 7 Wiring instructions

- Route cable from the light/s and cable from the power source to the terminal block.
- Strip approximately 6-8mm insulation from the cables for insertion into the terminal block.
- Run the power and light wires through the gasket hole and connect to the terminal block (see figure 3.)
- Connect the neutral from power source to N. Connect the active from the power source to L. (Refer to terminal block for positioning on base cover).
- Connect neutral from light/s to N. Connect active from the light/s to L. (see figure 3.)
- Position terminal block and screw main unit of Light Patrol to the base cover.
- A terminal is provided for terminating an earthing conductor. However, it is not compulsory to do this.

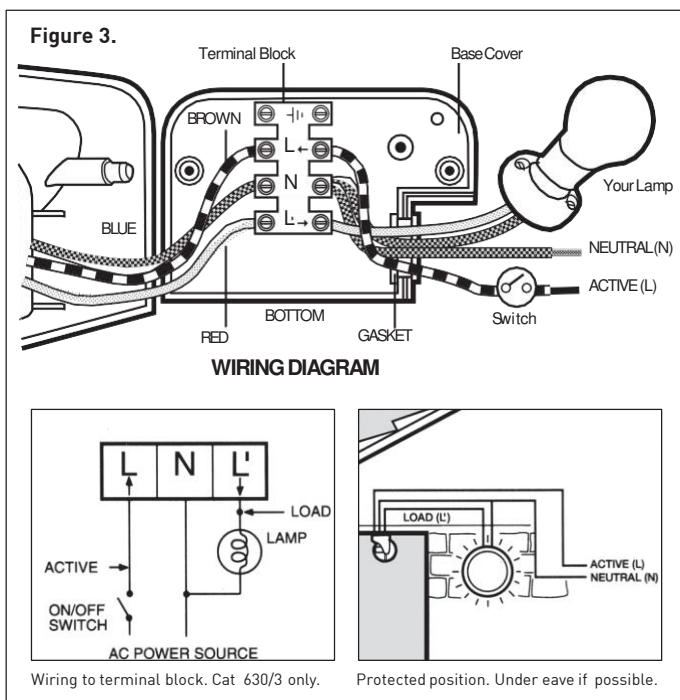

## 8 Test mode

Turn the time control (⌚) anti-clockwise and the light control (💡) clockwise to the test position (see figure 4.)

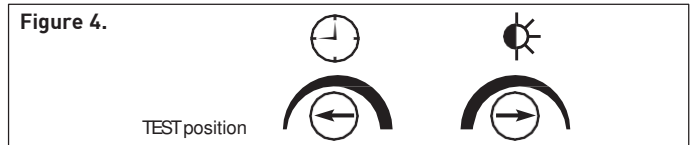

### Walk Test

Turn the wall switch on. The light/s should turn on immediately and will remain on while the detection unit warms up, for approximately 40 seconds. It will then turn off. Do a walk test and the light should turn on. This confirms that the wiring is correct and that the light is operational. Walk through the coverage area and adjust the Light Patrol according to your needs. Wait for about 5 seconds between each walk test. You may need to insert plastic blinkers (see page 2).

### Time adjustment

The time adjustment controls how long the light/s will stay on after movement is detected. This time varies between approximately 7 minutes (extreme clockwise) to approximately 8 seconds (extreme anti-clockwise).

### Light adjustment

The light or lux adjustment controls the light level at which the Light Patrol will switch on when in Auto Mode. At the fully clockwise position the unit will operate and sense movement 24 hours a day. At the fully anti-clockwise setting the unit will operate only at night. To obtain the correct setting turn knob clockwise until the light comes on at the desired lux level.

### Manual override (Cat 630/3 only)

There will be times when you wish the light to stay on regardless of motion. This may easily be achieved by turning the light off and on again within 1-2 seconds. The light/s will now remain on until manually switched off. To return the Light Patrol to the Auto Mode turn the power 'off' for longer than 10 seconds and then switch back on. Cat 630/3A and 630/3ABL requires special wiring for manual override (see figure 5).

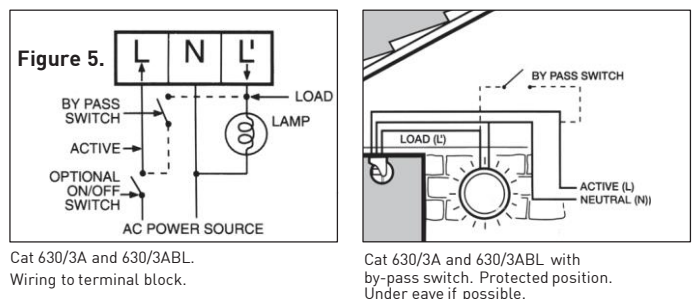

## 9 Trouble shooting suggestions

PROBLEM	LIKELY CAUSE	POSSIBLE SOLUTION
Light will not switch on when there is movement in detection area.	1. Power not available.	Check connections, switches and fuse.
	2. Faulty globe.	Replace globe.
	3. Incorrect wiring.	Recheck all wiring.
	4. Controls incorrectly set.	Change detection angle. Change light adjustment.
	5. Sensor positioned in wrong direction.	Change position and direction of sensor.
Light switches on for no apparent reason.	1. Air conditioner, heater, vents in proximity of sensor.	Reposition and redirect sensor.
	2. Animals or birds.	Possibly unavoidable. Redirect sensor.
	3. Interference on same circuit.	Check for arcing switches, replace noisy flouro tubes and/or starters. Consider connecting Light Patrol to different circuit.
	4. Reflective objects in detection area.	Redirect sensor and possibly reposition.
Light will not switch off after set time has elapsed.	1. Light is in manual mode (not in automatic). 630/3 only	Switch light off for at least 10 seconds then switch back on to return it to auto mode.
	2. Wiring is incorrect.	Recheck wiring.
	3. The unit has been damaged due to exceeding max load, use of an incompatible load type or failure of the light fitting (such as short circuit).	Identify and fix the cause of the failure and replace the unit with a new one.

### Warranty

Legrand Australia Pty Ltd warrants this product for a period of three years from the date of purchase. These goods come with guarantees that cannot be excluded under the Australian and New Zealand Consumer Laws. You are entitled to a replacement or a refund for a major failure and for compensation for any other reasonably foreseeable loss or damage. You are also entitled to have the goods repaired if the goods fails to be acceptable quality and the failure does not amount to a major failure. See the Warranty card enclosed with this product for further details.

### Customer Service

For all Customer Service and Technical Support please call Monday to Friday during business hours.

Legrand Australia  
1300 369 777  
[www.hpmlgrand.com.au](http://www.hpmlgrand.com.au)

Legrand New Zealand  
0800 476 009  
[www.hpmlgrand.co.nz](http://www.hpmlgrand.co.nz)

ABN: 31 000 102 661