



300 SERIES

PDL Technical Wiring Brochure

pdl.co.nz

Life Is On



by Schneider Electric

Wiring Guide

Mechanical & Electronic Solutions



Overview

PDL 300 Series introduces new features designed to enhance functionality, aesthetic appeal, and usability. 300 Series has a modular design so it's easy to combine functions now, and upgrade in the future.

Game changing modular mechanisms and grids with changeable skins and rockers for unrivalled customisation now and in the future.

Locking bar allows simple mechanism reorientation and sturdy locking for a fast, easy and secure install, reducing the risk of mechanism pushbacks.

Mechanical Switching

There is a range of electromechanical mechs available in 300 Series. This includes 10AX standard mechs through to 16AX mechs for commercial applications, double pole options and intermediate mechs.

There is also the option to add a subtle warm white LED to the switch assembly. You can set them as indicators to show which switches are in use, or as locators to locate a switch in the dark.

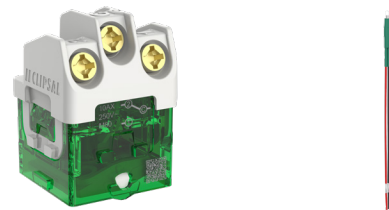

Electronic Switching

PDL 300 series includes a number of modular electronic switches, dimmers and timers/timeclocks incorporating ControlLink technology for multiway dimming and switching using standard wiring.

Our **Bluetooth Low Energy** range of mechanisms deliver simple configuration and control of Wiser Dimmers and Switches via the Wiser Room app on your phone or tablet. With this technology it makes life simple and easy.

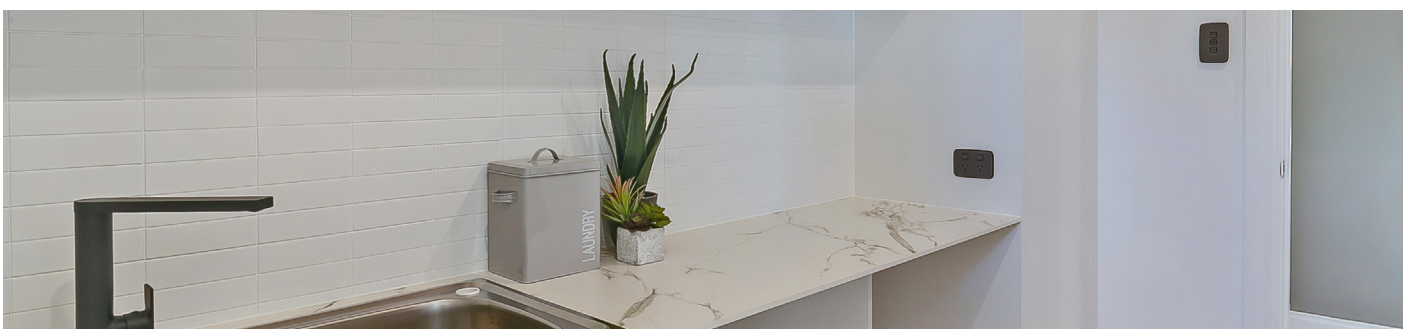



300 Series

The Mechs and Modules of the Future

The 300 Series Mechanisms is a very flexible platform, designed to be used with the Iconic and Pro Series plate ranges. Whether you have a residential or commercial application, 300 Series has the smart capabilities and extensive functionality required.

The Pro Series - clever, strong, easy

After extensive market research and listening to customer feedback, we have designed a range of switches and sockets for commercial buildings to answer your needs. Pro Series offers permanent circuit identification with large integrated windows. The skin is secured in place helping to protect your investment. Planning, commissioning and installing of the new Pro Series is quick and easy. Switches offer standard 300 Series mechanisms, and electronic modules such as sensors, timers and C-Bus. Sockets are available in several variants, and in horizontal and vertical orientation. There is also a wide choice of USB charging options available.

The Iconic Series - Irresistibly future-proof

Iconic is based around a unique grid plate, with a choice of three different skin designs that simply clip on top; Iconic, Iconic Styl, Iconic Essence.

Once the grids have been installed by an electrician, anyone can change the skins to suit a change in decor or preference. Simply clip off the existing skins and clip on the new design.

Mechanical Switching

LED indicator is permanently "ON" (Power Available Indicator)

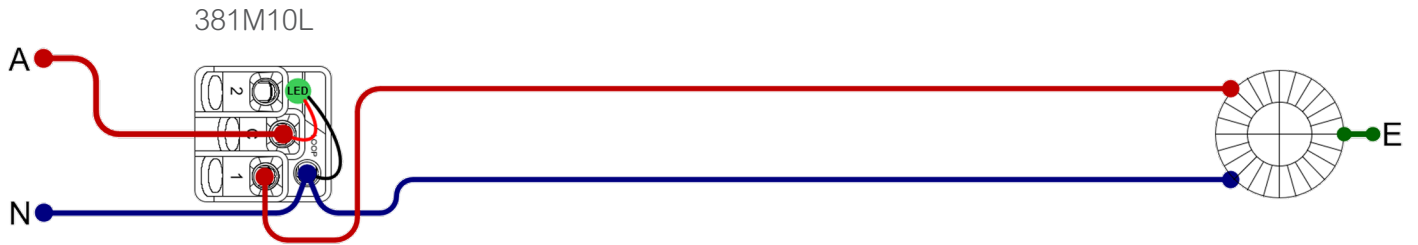

LED indicator "ON" when load is "ON"

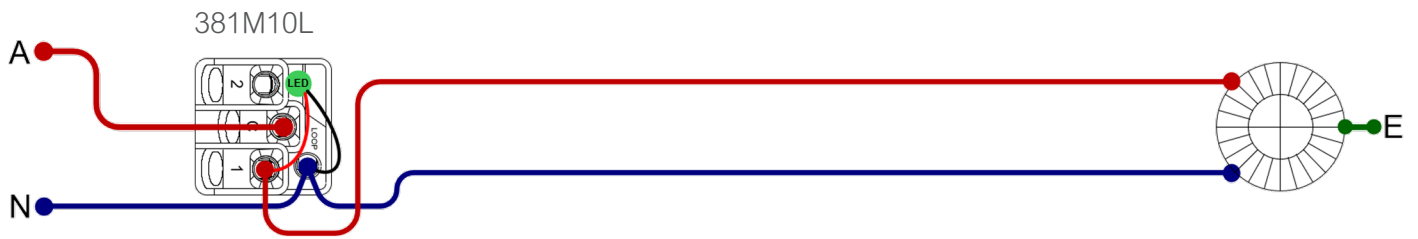

LED indicator "ON" when load is "OFF"- No neutral present at switch

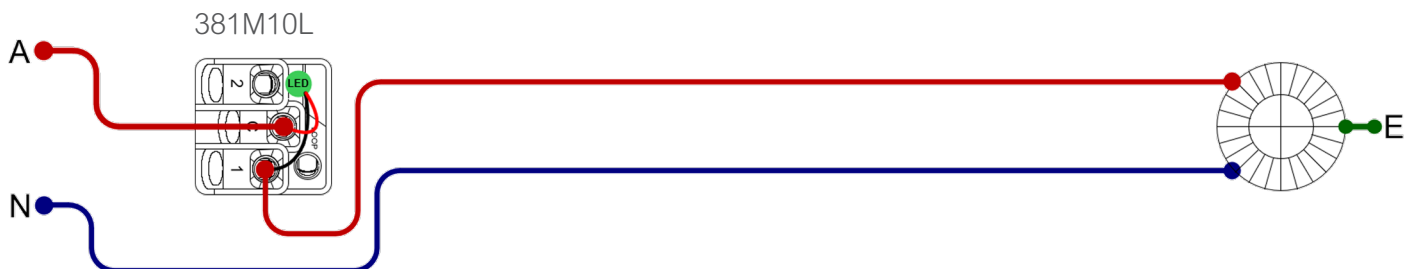

Mechanical Switching

LED indicator is "ON" when load is "OFF"

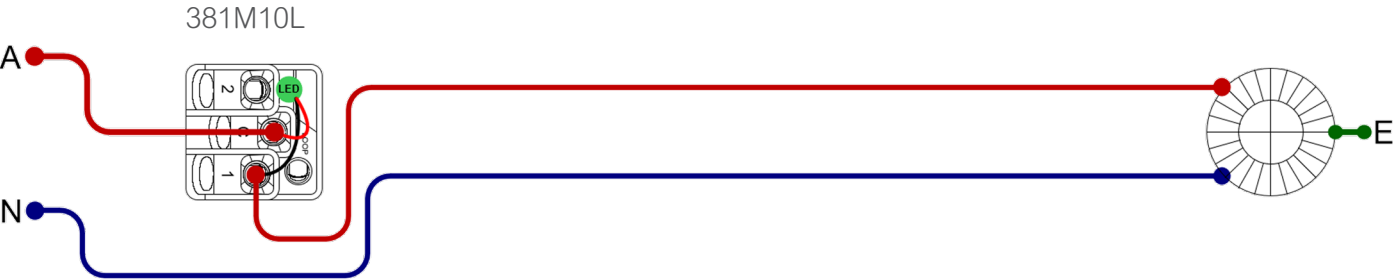

2-Way switching, LED indicator "ON" when load is "ON"- Neutral present at switch

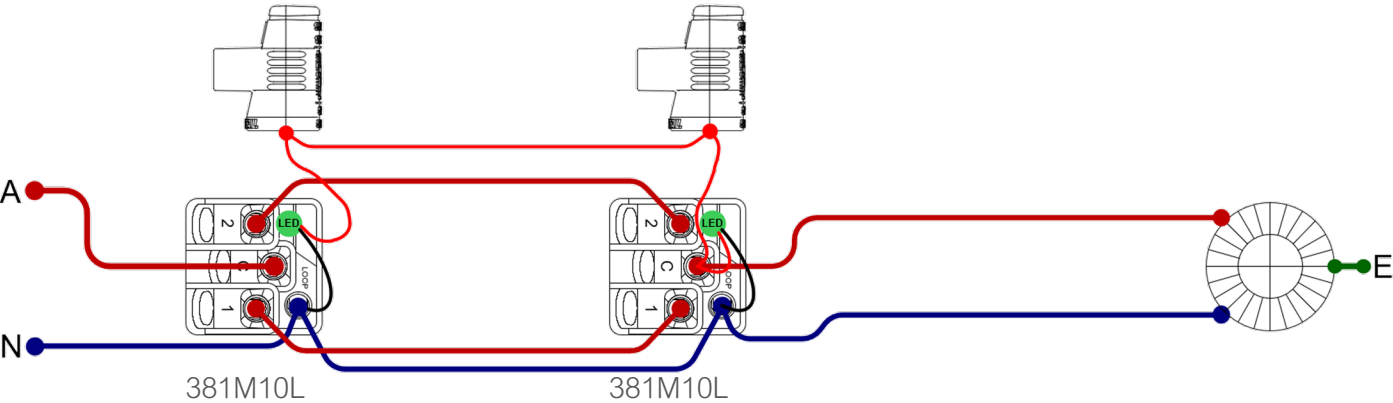

2-Way switching, LED indicator "ON" when load is "OFF"- Neutral present at switch

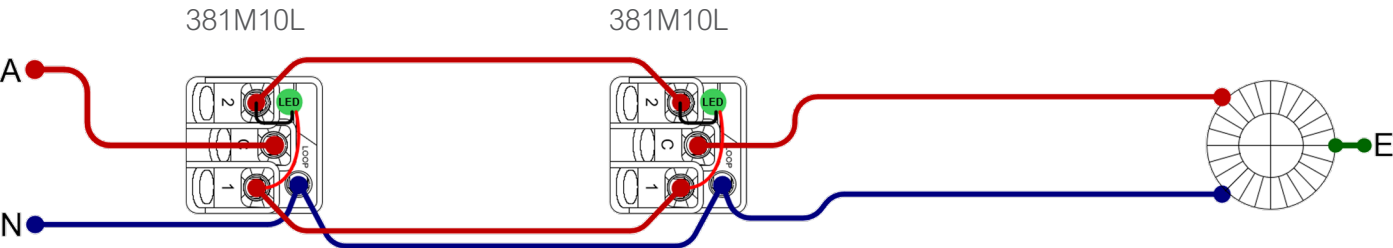

Mechanical Switching

2-Way switching, LED indicator is "ON" when load is "OFF"- No neutral present at switch

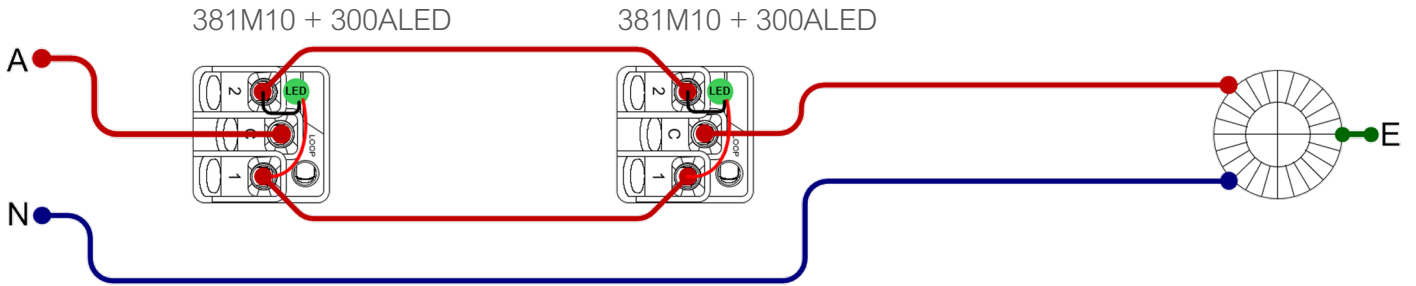

Multi-way switching, LED indicator is "ON" when load is "OFF"- No neutral present at switch

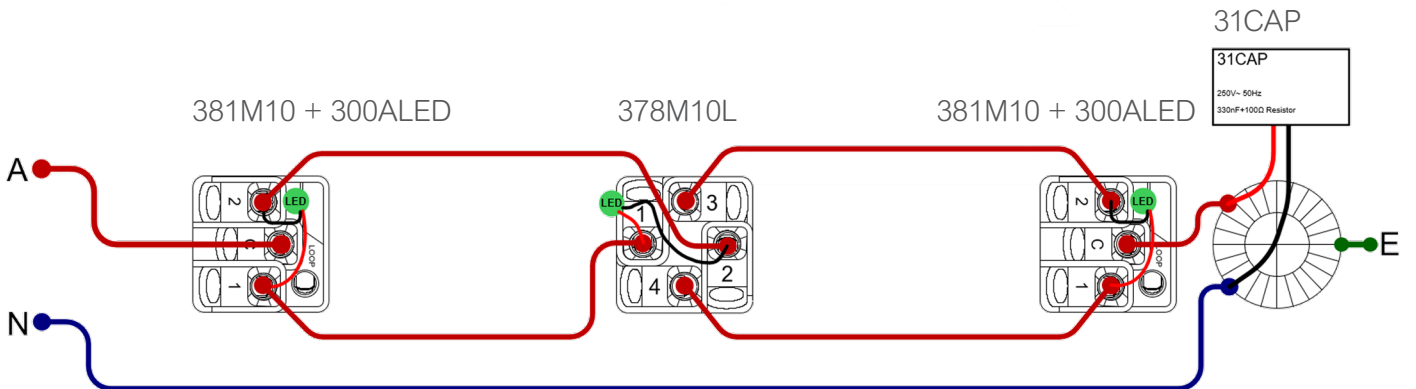

***31CAP to be installed in parallel with the load to counter for larger current leakage.

Switch and Rotary Dimmer

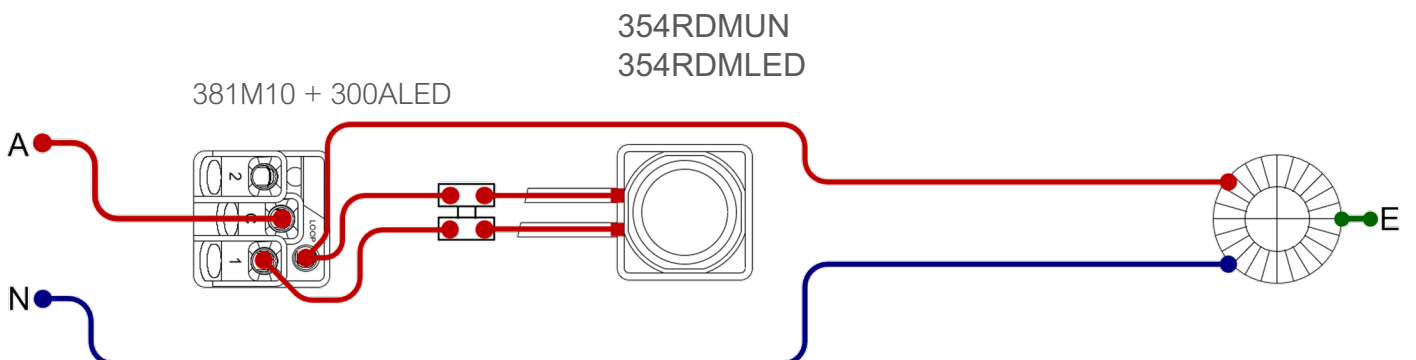

Mechanical Switching

2-Way Switching with Rotary Dimmer

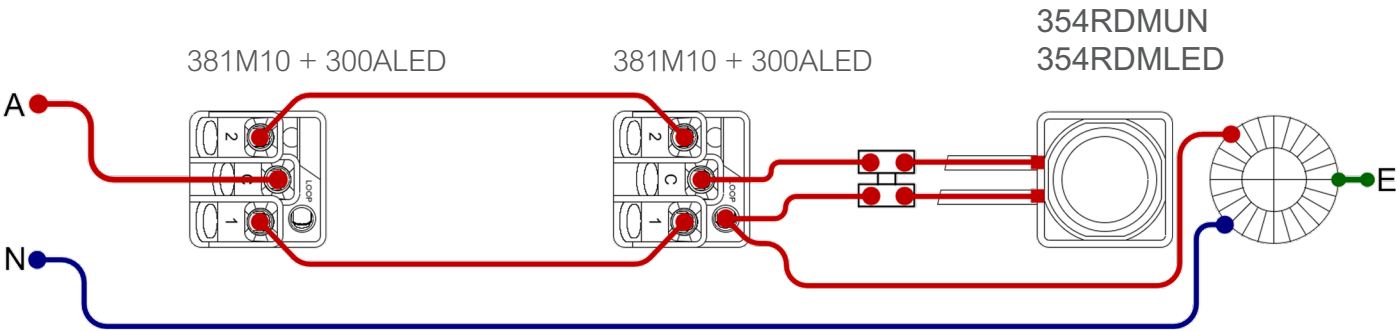

Rotary Fan Controller

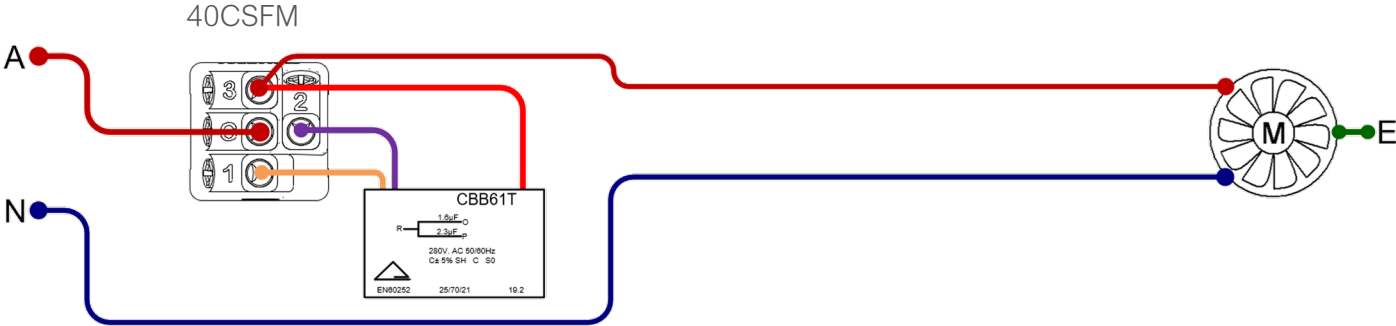

Double Pole Switching

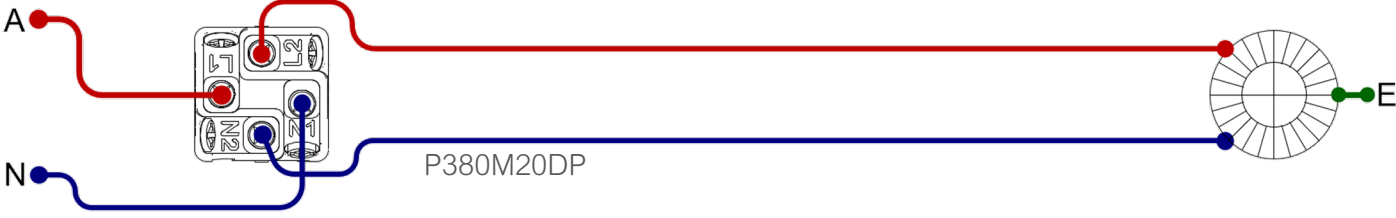

Mechanical Switching

Switching with LED indicator module
LED indicator "ON" when load is "ON"

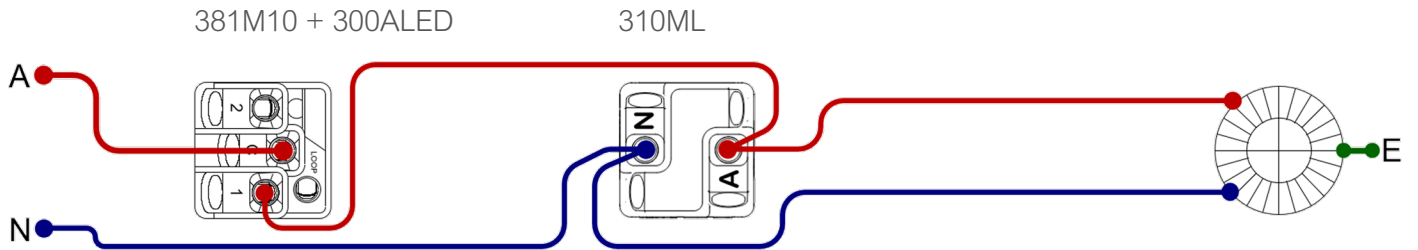

Switching with LED indicator module
LED indicator "ON" when load is "OFF"

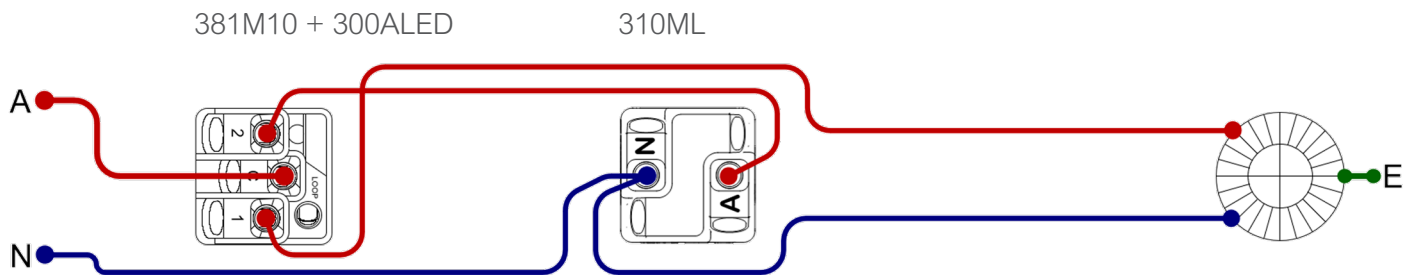

Switching with LED indicator module
LED indicator "ON" permanently (Power Available Indicator)

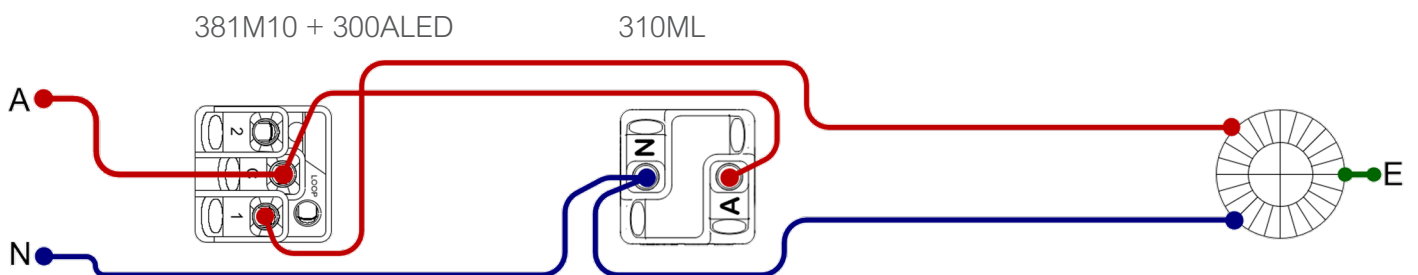

Mechanical Switching

3 Position momentary press for blind control

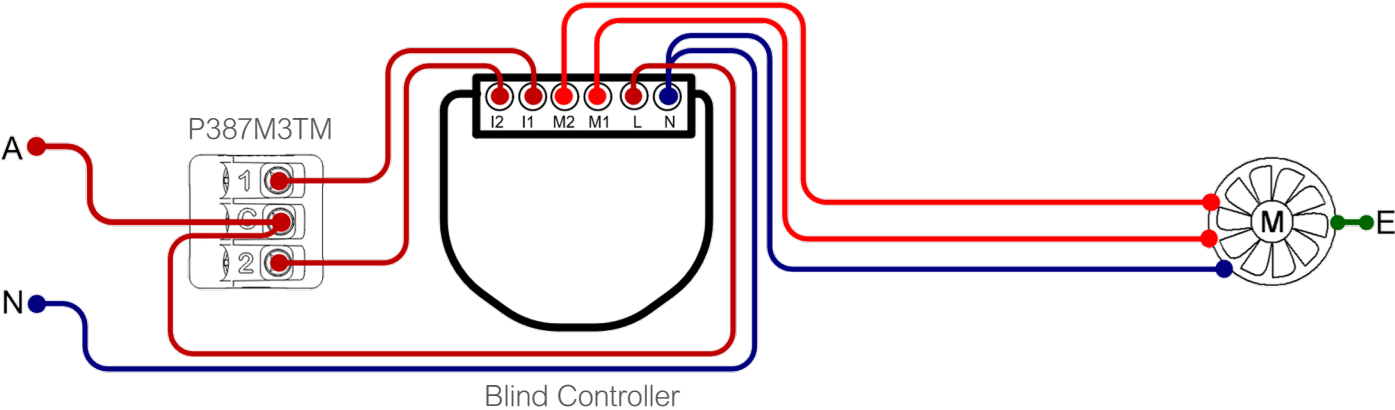

Clever, Strong, Elegant



Electronic Switching

2-Way Switching (LED indication at Master only)
-2 Wire Slave, 3 Wire Master

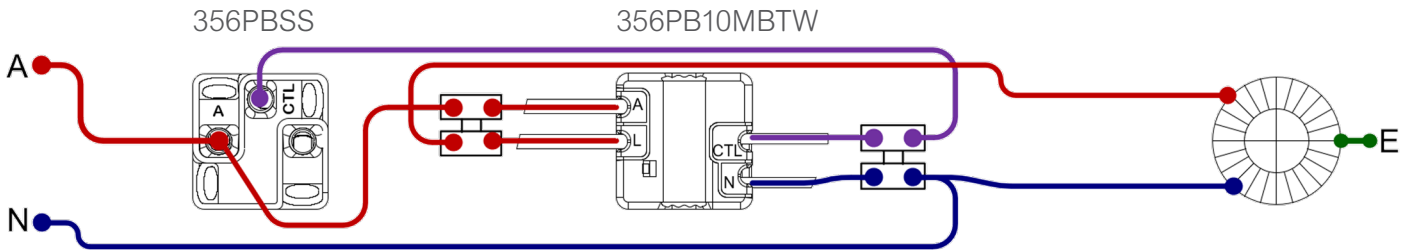

2-Way Switching (LED indications at both ends)
-3 Wire Slave & Master

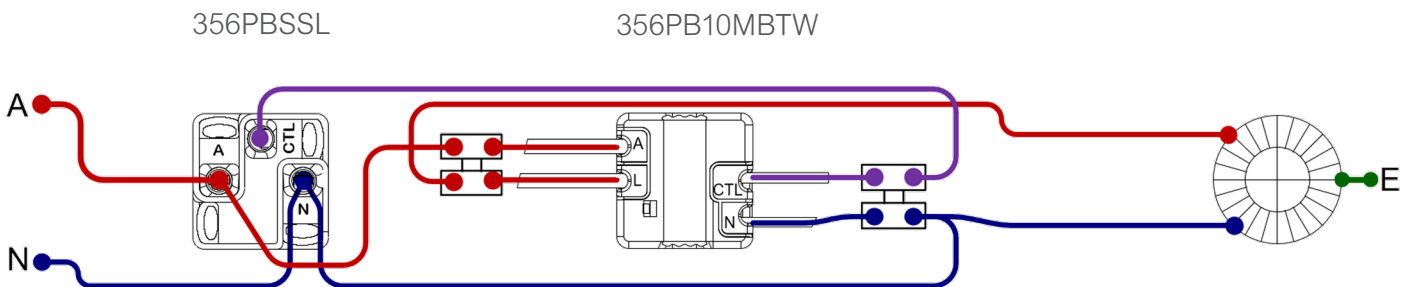

2-Way Dimming (LED indication at Master only)
-2 Wire Slave & Master

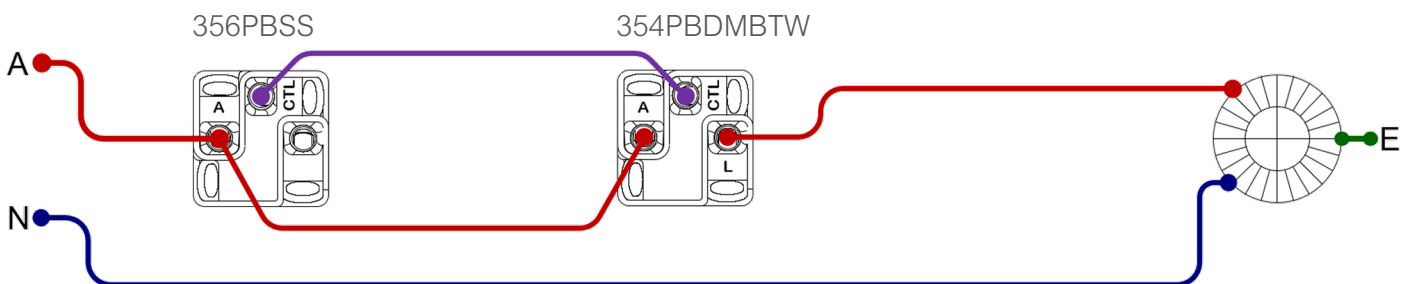

Electronic Switching

2-Way Dimming (LED indications at both ends)
-3 Wire Slave, 2 Wire Master

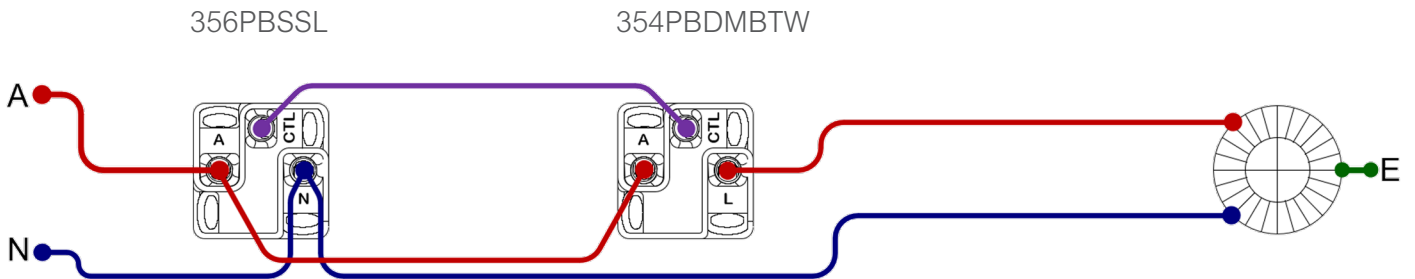

2-Way Switching and/ or Dimming (LED indicators at both ends)
-3 Wire Slave & Master

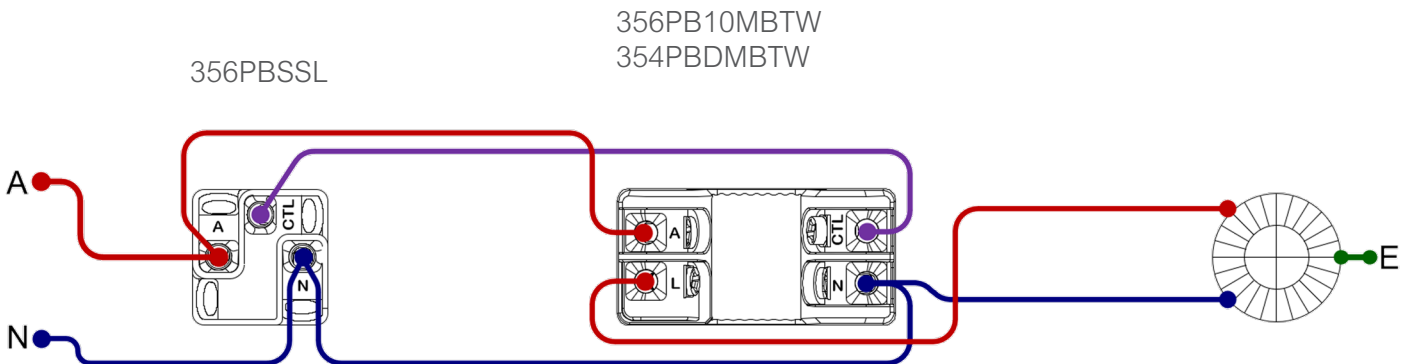

2-Way Switching and/ or Dimming (LED indication at Master only)
-2 Wire Slave, 3 Wire Master

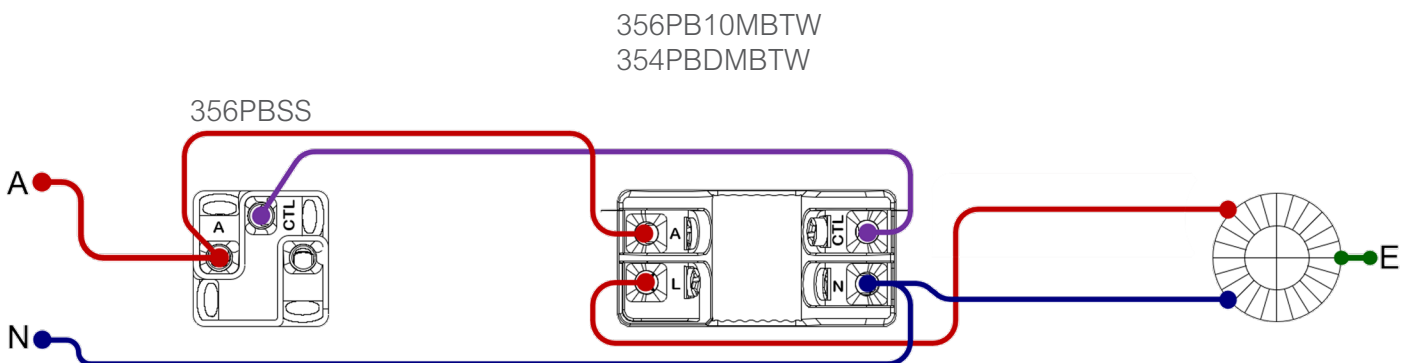

Electronic Switching

Switching with PIR Sensor

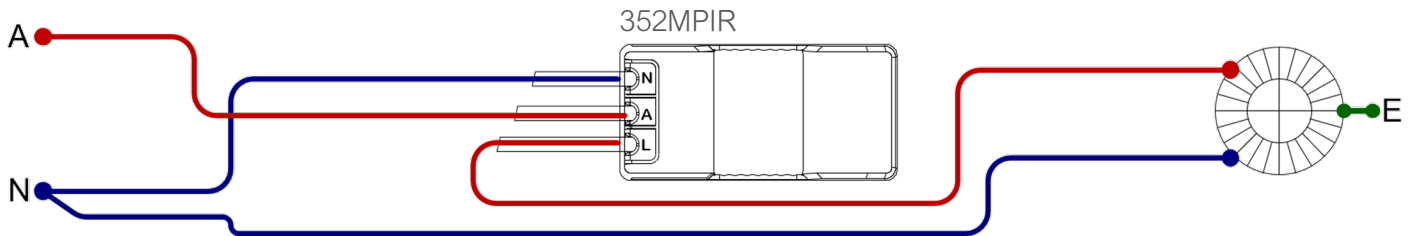

Switching with PIR Sensor with override switch

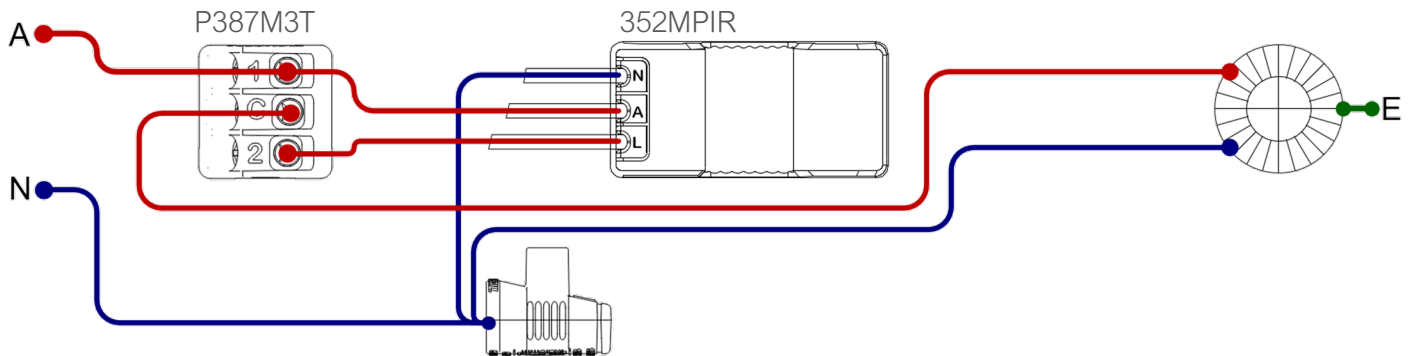

Product References

| Mechanisms & Modules | Description |
|----------------------|---|
| 381M10 | Switch Mechanism, 1/2 way, 250VAC, 10AX |
| 381M20 | Switch Mechanism, 1/2 way, 250VAC, 20A/16AX |
| 387M3TM | Pro Series, Switch Mechanism, Bell Press Return, 250VAC, 10A |
| 380M32 | Switch Mechanism, 1 way, 250VAC, 32A |
| 380M20DP | Switch Mechanism, Double Pole, 250VAC, 20AX |
| P380M20DP | Pro Series, Switch Mechanism, Double Pole, 250VAC, 20AX |
| 378M10L | Switch Mechanism, Intermediate, 250VAC, 10AX, LED |
| 40CSFM | Fan Speed Controller Mechanism, 3 Speed, 250VAC, 75VA |
| P387M4R3 | Pro Switch Mechanism, Rotary, 4 Position, 250VAC, 10A, OFF-1-2-3 |
| P387M4R2 | Pro Series, Switch Mechanism, Rotary, 4 Position, 250VAC, 10A, OFF-1-OFF-2 |
| 387M3T | Switch Mechanism, 3 Position, 250VAC, 10A |
| 310ML** | LED Mechanism, Power Available, (**=LED Colour, Green -GR, Red -RD), 250VAC |
| 310MLPA | LED Mechanism, Marked Power Available, (Amber) 250VAC |
| 310ML24** | LED Mechanism, Power Available, (**=LED Colour, Green -GR, Red -RD), 24VDC |
| 300ALED | LED Module, 250VAC, Warm White, To suit 381M10 & 381M20 |
| 356PB10MBTW | Push-Button Wiser Switch, 10AX, 3-wire with BLE app config |
| 354PBDMBTW | Push-Button Wiser Dimmer, LED, 300W, 3-wire with BLE app config |
| 356PB5M | Push-Button Dimmer, Universal, 300W 2-wire |
| 41E6PBTC3SBM | Push-Button Time Clock, 6AX, 3-wire with BLE app config |
| 356PB5S | Push-Button ControlLink, Remote Momentary Switch 50mA |
| 356PB5SL | Push-Button ControlLink, Smart Remote with LED Indicator |
| 354RDMUN | Rotary Dimmer, Universal, 350W, 2-wire |
| 354RDMLD | Rotary Dimmer, LED, 350W, 2-wire |
| 352MPIR | PIR Motion Sensor, 150W LED, 3-wire, 5m range |

Dimensional Drawings

381M10
381M20

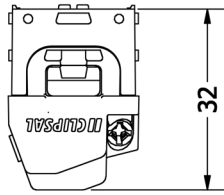
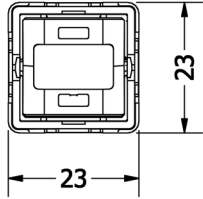

378M10L

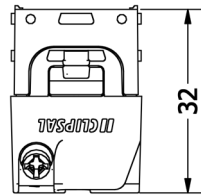
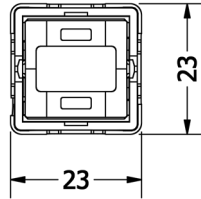

387M3T
387M3TM

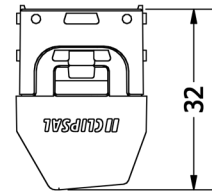
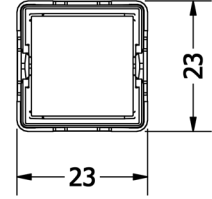

380M20DP

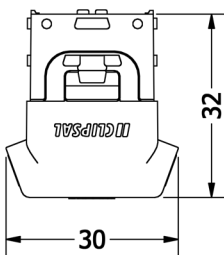
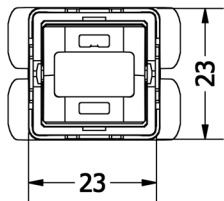

380M32

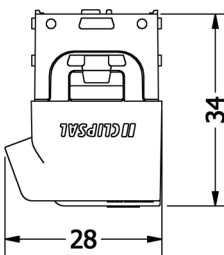
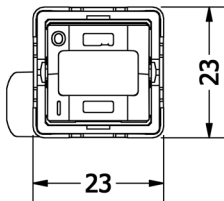

Dimensional Drawings

354RDMUN
354RDMLD

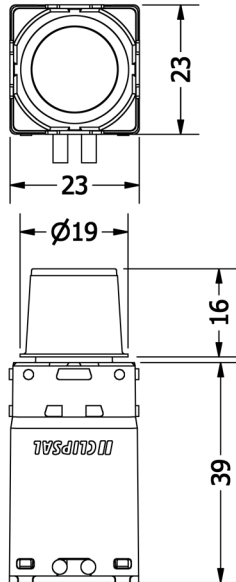

387M4R
40CSFM

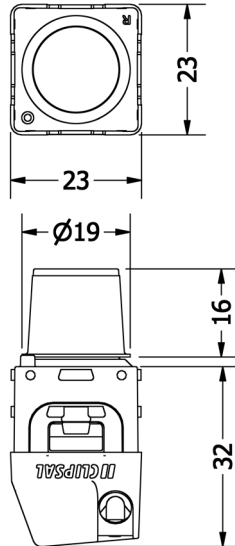

310ML
310ML24

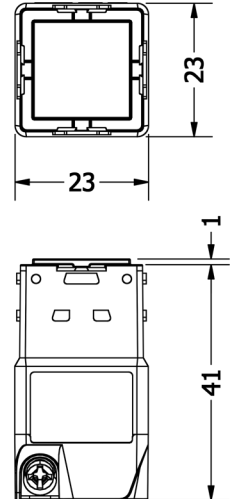

356PBSM

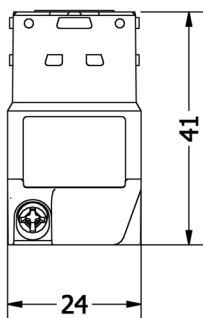
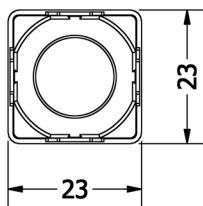

356BP2MBTW

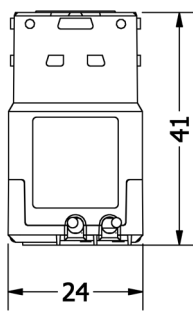
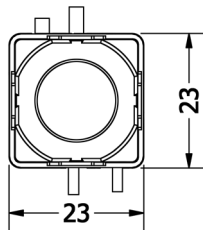

356PBSS
356PBSSL

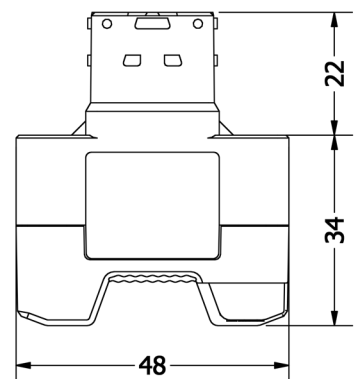
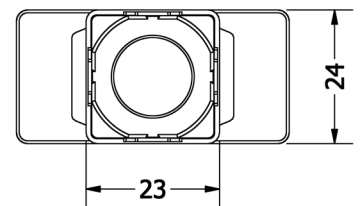

Dimensional Drawings

352MPIR

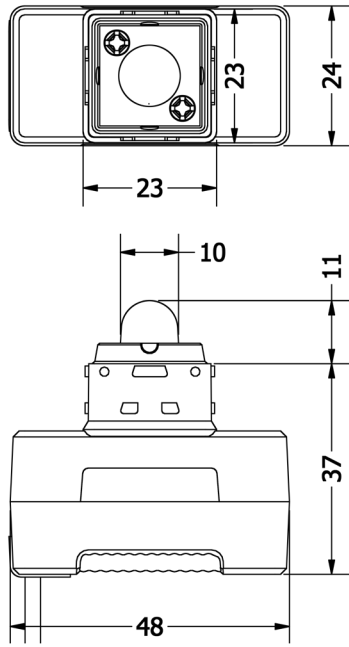

300ALED

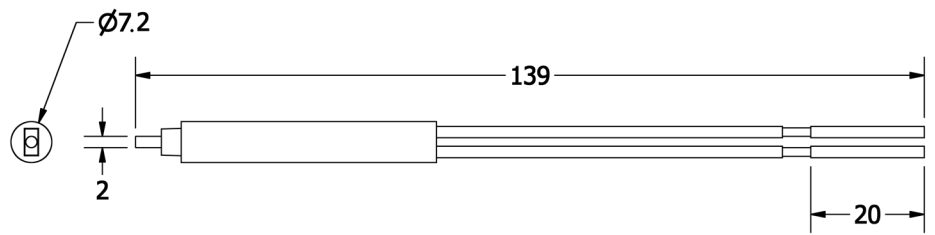

Connection Type



381M20
387M3TM, 381M10L

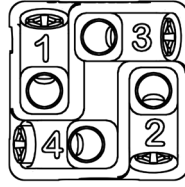

378M10L

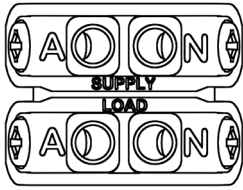

380M20DP

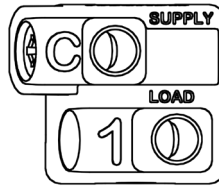

380M32

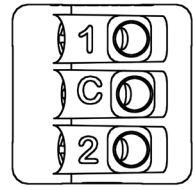

387M3T

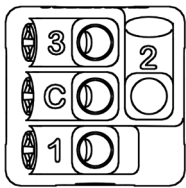

387M4R3
387M4R2

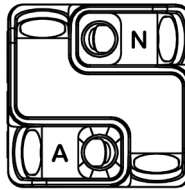

310ML

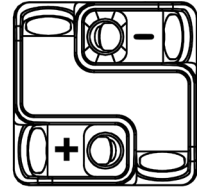

310ML24

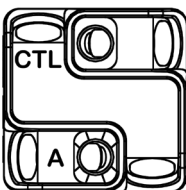

356PBSS

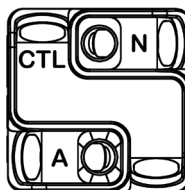

356PBSSL

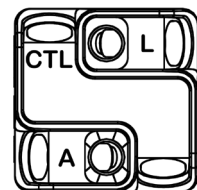

354PBUDM

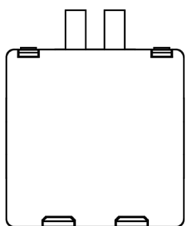

354RDMUN
354RDMLED

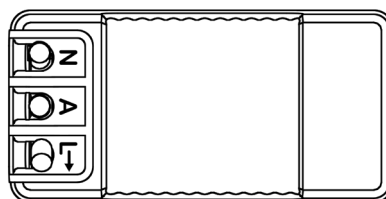

352MPIR

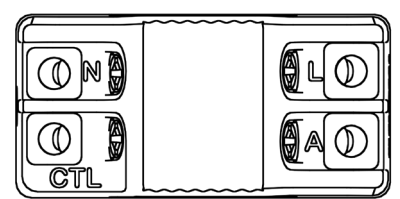

356PB10MBTW
354PBDMBTW



Best Design Awards
Winner 2017



Best Design Awards
Winner 2019



For more information about the 300 Series mechanisms and modules, contact your local PDL and Schneider Electric Representative, electrical wholesaler, or visit pdl.co.nz

Schneider Electric (NZ) Ltd.
Level 2, Building 6,
60 Highbrook Drive,
Highbrook, Auckland 2013
se.com/nz

Email: sales@nz.schneider-electric.com

Consumer Support Enquiries
Phone: 0800 652 999

©2020 Schneider Electric. All Rights Reserved. This document has been printed on recycled paper.
GDE9191600

pdl.co.nz

Life Is On



by Schneider Electric